

## Description

A highly reliable and legible readout capable of maintenance free operation over years in harsh environments (IP65 - Nema 4x). Moderate power consumption yields longer life and lower lifetime cost.

The stainless steel front will elegantly fit any office environment as well as outdoors in an industrial plant.

Highest quality LEDs are used to extend product life and reliability.

Delivered complete for normal use. Additional selection of options such as other interfaces, power and mounting hardware is available.

## Quick Data

### DISPLAY CHARACTERISTICS

Character Height	125 mm
Number of digits	6
Extra segments	Stop & Go (red/green) light fields
Resolution	Seven segments and decimal point, colons could be made active instead of comma
Technology	30 degree LEDs with auto intensity
Designator	Auto or Permanent label sticker (eg. kg, t, rpm, °C, pH)
Backlight	Not applicable
Power	Max. 25W

### MECHANICAL

Size casing	606 mm x 256 mm x 65 mm (l x h x d)
Size inc. bracket etc	606 mm x 256 mm x 92 mm (l x h x d)
Materials	1.25 mm stainless steel front, acrylic/PC glass. Back is laquered 1,5mm aluminium
Protection	IP65 waterproof housing, guaranteed for unprotected outdoor use and hose down washing.
Operating temp.	-15°C to +65°C (intermittent up to +75°C). No problem found down to -35°C (trafo)
Weight	3,5 kg net, Shipping: 3,9 kg (70 x 30 x 13 cm)

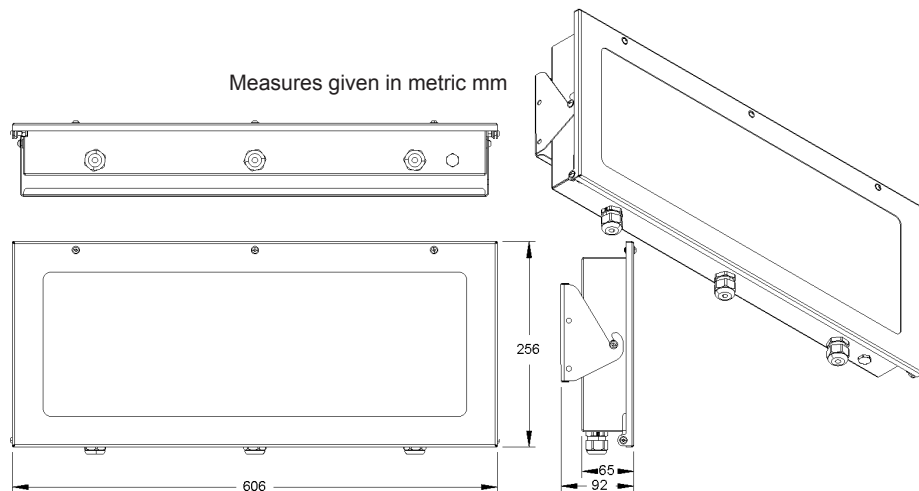

©2012 Norsk Display AS: This leaflet is not complete without a specific manual for all installed electronic cards.

©2012-Aug-20 Norsk Display AS

## ND7046 : 125mm LED Numerical Display Stop/Go



- Reading distance 1 to 55m
- Red 'Stop' and green 'Go' signal
- Alternative controls for Stop/Go
- IP65 and wide temperature range
- Auto Intensity & low power 0,3 to 35W
- Perfect in direct sunlight - and at night

# User's Guide

## Ordering

N6/1-125-A (**N**umeric **6** digits/ **1** line - **125** mm digit height - **A**mber LED )

Standard configuration is:

- Serial data controller (RS-232, RS-485 and TTY20mA)
- Power requirement: 100 to 240Vac 50/60Hz
- Tilttable bracket for wall- and pole mounting
- 3 x M20 cable inlets for cable dimensions  $\varnothing=6$  to 13mm

.... and as you always should expect: highest quality components and unparalleled support.

### Option:Power

12Vdc regulated voltage may be used.

### Option:Interface

- Ethernet 10/100
- WiFi
- A/D 20mA (4..20mA)
- Counter Up/Down
- Time/Date GPS
- Temperature (digital)
- ...

### Option:Mechanical

- Out-from-Wall Mount
- Ceiling Suspension
- Sticker/label (°C,m,%,...)



norskdisplay



Norsk Display AS  
Tel: (+47) 3288 7000  
Fax: (+47) 3288 7001  
sales@norskdisplay.com

## Mechanical Mounting

1

Mounting the display should be quite straightforward, just make sure every fitting is properly tightened. Safeguard the installation to avoid health hazards!

### You need to supply:

Fasteners for your specific needs, e.g: wood screws, straps to go around the pole

## Tools

2



- Torx 20 + 25 + 30

## Wall Mounting

3

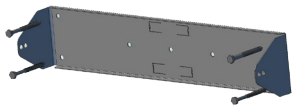

- Screws must be supplied by the installer (typ 6x50mm)

## Pole Mounting

4

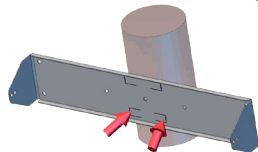

Press tags to fit, then use steel straps to fix. (User supplied)

## Option:Control

!

- Stop/Go light is controlled via the serial protocol or by separate optocoupler input lines (extra option).

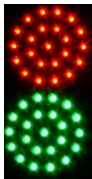

## Did you know...

?

- When mounting the display you should make sure it is tilted to face the viewer. Tilting downwards will ensure that you avoid direct reflection of the sky and the sun - thus improving contrast.

## Did you know...

?

- A smaller version of this display is available with 67mm character height. Ask for ND7037A.

Extremely reliable and long life LCD displays are also available.

## Did you know...

?

- Service or installation help is best given through your normal supplier. However, if needed, the factory will always help you as best they can. Happy users are our best sales argument.

## Electrical Mounting

A



The enclosure must be connected to Protective Earth. This is vital for safe operation. Failure to observe correct grounding may cause serious injury.

Grounding is further vital for full CE compliance and must be provided for correct operation.

## Disconnect power when servicing the display.

## Tools

B



- Torx 20 + 25

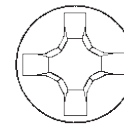

- Phillips #2/1

## Cable Dimension

C

- ø 6..13mm outer dia
- conductors 0,2-0,75mm<sup>2</sup> (AWG 24 to AWG18)
- Keep ground leads short

## Cable Inlets

D

- M20x1,5 is used
- Hand tighten
- Block unused glands!



Tip: use strips for extra pull-out protection

## Dismantling

E

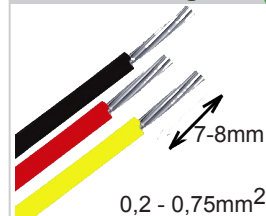

## Connection

F

- Follow directions in separate Users Guide for the installed card

## Option:Mounting

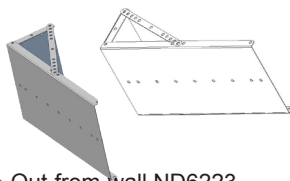

- Out-from-wall ND6223 (adjustable angle)

## Option:Labels

pcs  
stk % °C mm

- Any adhesive designator sticker.

## Feedback

*We appreciate any feedback. Good or bad; it will help us serve you better.*

*Suggestions or critical remarks are best sent to the support email.*

## Option:

*Want some other elements or different behaviour? Just ask the factory - it may already be available. It may even be free of cost. We will give you quick feedback.*

## Option:Electrical



- Ethernet ND5129 card

## Support

- Free protocol adaption for your equipment!
- Help during installation

support email:  
sales@norskdisplay.com  
Tel: [+47] 3288 7000